

Yale®

(GB) Installation - (IT) Installazione - (DE) Installation - (NO) Installasjon - (SE) Installation - (DK) Installation.

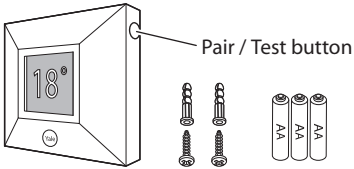

(IT) Associazione/test - (DE) Verbinden/Testen - (NO) Tilkobling/Test - (SE) Para/Testa - (DK) Tilslut/test
SR-RS

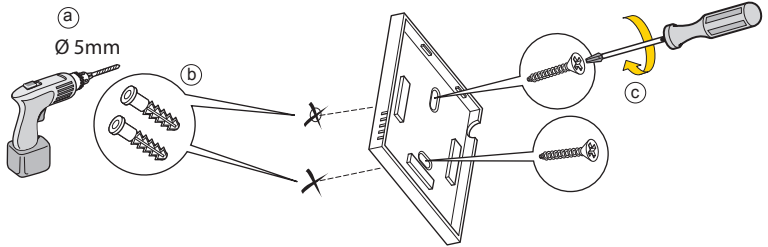
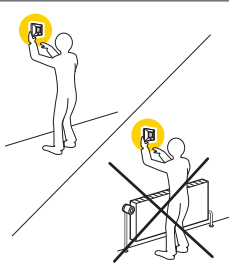
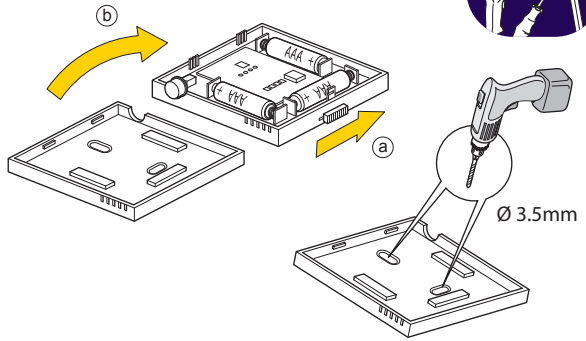

(GB) Please see your Yale Smartphone Alarm System Instruction manual for the following: Adding this component to your Alarm, Installing, Changing the batteries, Troubleshooting.

(IT) Si prega di consultare il manuale istruzioni dell'allarme Yale Smartphone Alarm per le seguenti operazioni: Aggiungere questo componente al vostro allarme, Installazione, Sostituzione batterie, Risoluzione dei problemi.

(DE) Bitte lesen Sie Ihre Anleitung für Ihr YALE Smartphone Alarm Set aufmerksam zum Thema: Neues Zubehör hinzufügen, Installation, Batteriewechsel sowie Fehlerbehebung.

(NO) Vi refererer til den medfølgende brukermanualen av Yale Smartphone Alarm systemet for følgende informasjon: Legge til tilleggsutstyr, Montere enheter, Bytte batterier, Problemløsning.

(SE) För nedanstående hänvisas till Yale Smartphone Alarm system manualen: Lägga till en komponent till ditt larmsystem, Installation, Batteribyte, Felsökning.

(DK) Se hovedmanualen til Yale Smartphone Alarm System, som indeholder vejledning i fig.: tilføj komponenter, installation, batteriskift, fejlfinding.

(GB) Environment - (IT) Ambiente - (DE) Umgebung - (NO) Miljø - (SE) Miljö - (DK) Miljø.



Housings ABS/polycarbonat

(IT) Involucro di TUTTI i dispositivi ABS/polycarbonato
(DE) Alle Geräte, Gehäuse ABS Polycarbonat
(NO) ALLE komponenter. Deksel av ABS/polykarbonat
(SE) Alla komponenter, Plasthölje ABS/Polycarbonat
(DK) Alle komponenter, ABS/polycarbonat

-10°C to 40°C

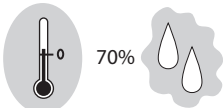

RoHS

PACKAGING

An ASSA ABLOY Group brand

ASSA ABLOY

SR-RS-MI-v04



(GB) How does it work - (IT) Come funziona - (DE) Wie es funktioniert - (NO) Hvordan virker det - (SE) Hur fungerar det - (DK) Hvordan virker det



Pair and test planned location for stable radio performance

(IT) Associazione nuovo dispositivo. Esegui un test della posizione programmata dei componenti - (DE) Verbinden neuer Geräte. Testen Sie Ihren gewählten Standort - (NO) Tilkobling av ekstrastyr. Test for stabile trådløse signaler - (SE) Para in nytt tillbehör. Test radiostyrka - (DK) Tilslut ekstrastyr. Test for stabil trådløs forbindelse



Radio 2,4GHz

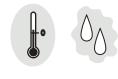

18°
72%

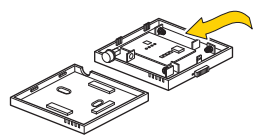
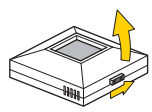

3 x 1.5v AAA

